

Patient Information
AEROSPAN™ (AIR-OH-SPAN)
(flunisolide)
Inhalation Aerosol

Note: For Oral Inhalation Only

Read this Patient Information leaflet before you start using AEROSPAN Inhalation Aerosol and each time you get a refill. There may be new information. This information does not take the place of talking with your healthcare provider about your medical condition or your treatment. If you have any questions about AEROSPAN Inhalation Aerosol, ask your healthcare provider or pharmacist.

What is AEROSPAN Inhalation Aerosol?

AEROSPAN Inhalation Aerosol is a prescription medicine used for the long-term (maintenance) treatment of asthma to control and prevent asthma symptoms in adults and children 6 years of age and older.

AEROSPAN Inhalation Aerosol contains flunisolide, which is a man-made (synthetic) corticosteroid. Corticosteroids are natural substances found in the body. Inhaled corticosteroids help reduce airway inflammation that can lead to asthma symptoms.

When inhaled regularly, AEROSPAN Inhalation Aerosol will help to prevent and control asthma symptoms.

AEROSPAN Inhalation Aerosol is not a bronchodilator and does not treat sudden symptoms of an asthma attack, such as wheezing, cough, shortness of breath, and chest pain or tightness. Always use a fast-acting bronchodilator medicine (rescue inhaler), such as albuterol, to treat sudden symptoms.

Who should not use AEROSPAN Inhalation Aerosol?

Do not use AEROSPAN Inhalation Aerosol:

- to treat the symptoms of a sudden asthma attack or status asthmaticus.
- if you are allergic to flunisolide or any of the ingredients in AEROSPAN Inhalation Aerosol. See the end of this Patient Information leaflet for a complete list of ingredients in AEROSPAN Inhalation Aerosol.

AEROSPAN Inhalation Aerosol is not for use in children less than 6 years of age.

What should I tell my healthcare provider before using AEROSPAN Inhalation Aerosol?

Before you use AEROSPAN Inhalation Aerosol tell your healthcare provider if you:

- have or have had eye problems such as increased intraocular pressure, glaucoma, or cataracts.
- have any infections.
- have or had tuberculosis or herpes simplex of the eye.
- have not had or been vaccinated for chicken pox or measles, or have recently been near anyone with chicken pox or measles.
- are planning on having surgery.
- are pregnant or plan to become pregnant. It is not known if AEROSPAN Inhalation Aerosol will harm your unborn baby. Talk to your healthcare provider if you are pregnant or plan to become pregnant.
- are breastfeeding or plan to breastfeed. It is not known if AEROSPAN Inhalation Aerosol passes into your breast milk. Talk to your healthcare provider about the best way to feed your baby if you are using AEROSPAN Inhalation Aerosol.

Tell your healthcare provider about all medicines you take, including prescription and non-prescription medicines, vitamins, and herbal supplements.

Know all the medicines you take. Keep a list of them and show it to your healthcare provider and pharmacist when you get a new medicine.

How should I use AEROSPAN Inhalation Aerosol?

- Read the Instructions for Use at the end of this leaflet for specific information about the right way to use AEROSPAN Inhalation Aerosol.
- Use AEROSPAN Inhalation Aerosol exactly as your healthcare provider tells you to use it. **Do not** take more of your medicine, or take it more often than your healthcare provider tells you.
- You must use your AEROSPAN Inhalation Aerosol regularly. It may take 2 weeks or longer after you start using AEROSPAN Inhalation Aerosol for your asthma symptoms to get better. Call your healthcare provider right away if your breathing problems do not improve or get worse. Call your healthcare provider if your symptoms do not improve after 4 weeks. **Do not stop using AEROSPAN Inhalation Aerosol, and do not** change the amount of AEROSPAN Inhalation Aerosol you take, without talking to your doctor. If you miss a dose, just take your next scheduled dose when it is due.
- An adult should help a child use their AEROSPAN Inhalation Aerosol.

What are the possible side effects of AEROSPAN Inhalation Aerosol?

AEROSPAN Inhalation Aerosol may cause serious side effects, including:

- **fungal infections (thrush) in your mouth or throat.** Tell your healthcare provider if you have any redness or white colored patches in your mouth or throat. Rinse your mouth after you use your AEROSPAN Inhalation Aerosol.

- **immune system problems that may increase your risk of infections.** You are more likely to get infections if you take medicines that may weaken your immune system. Avoid contact with people who have contagious diseases such as chicken pox or measles while you use AEROSPAN Inhalation Aerosol. Symptoms of an infection may include:

- fever
- pain
- aches
- chills
- feeling tired
- nausea
- vomiting

Tell your healthcare provider about any signs of infection while you are using AEROSPAN Inhalation Aerosol.

- **decreased adrenal function (adrenal insufficiency).** Adrenal insufficiency is a condition in which the adrenal glands do not make enough steroid hormones. Symptoms of adrenal insufficiency include:
 - tiredness
 - weakness
 - dizziness
 - nausea
 - vomiting
- **decreased bone mass (bone mineral density).** People who use inhaled steroid medicines for a long time may have an increased risk of decreased bone mass which can affect bone strength. Talk to your healthcare provider about any concerns you may have about bone health.
- **slowed or delayed growth in children.** A child's growth should be checked regularly while taking AEROSPAN Inhalation Aerosol.
- **eye problems such as glaucoma and cataracts.** If you have a history of glaucoma or cataracts or have a family history of eye problems, you should have regular eye exams while you use AEROSPAN Inhalation Aerosol.
- **increased wheezing (bronchospasm)** can happen right away after using AEROSPAN Inhalation Aerosol. **Stop using AEROSPAN Inhalation Aerosol and use an inhaled fast-acting bronchodilator (rescue inhaler) right away.**

The most common side effects with AEROSPAN Inhalation Aerosol include:

- sore throat (pharyngitis)
- runny nose (rhinitis)
- headache
- sinusitis
- increased cough

Tell your healthcare provider about any side effect that bothers you or that does not go away.

These are not all of the possible side effects of AEROSPAN Inhalation Aerosol. For more information, ask your doctor or pharmacist.

Call your healthcare provider for medical advice about side effects. You may report side effects to FDA at 1-800-FDA-1088.

How should I store AEROSPAN Inhalation Aerosol?

- Store AEROSPAN Inhalation Aerosol at room temperature between 59°F and 86°F (15°C to 30°C).
- **Do not** puncture the AEROSPAN Inhalation Aerosol canister.
- **Do not** store the AEROSPAN Inhalation Aerosol canister near heat or a flame. Exposure to temperature above 120°F (49°C) may cause the canister to burst.
- **Do not** throw the AEROSPAN Inhalation Aerosol canister into a fire or an incinerator.
- **Do not** freeze AEROSPAN Inhalation Aerosol.
- Safely throw away medicine that is out of date or no longer needed.

Keep AEROSPAN Inhalation Aerosol and all medicines out of the reach of children.

General information about the safe and effective use of AEROSPAN Inhalation Aerosol.

Medicines are sometimes prescribed for purposes other than those listed in a Patient Information Leaflet. Do not use AEROSPAN Inhalation Aerosol for a condition for which it was not prescribed. Do not give AEROSPAN Inhalation Aerosol to other people, even if they have the same symptoms that you have. It may harm them.

This Patient Information summarizes the most important information about AEROSPAN Inhalation Aerosol. If you would like more information, talk with your healthcare provider. You can ask your pharmacist or healthcare provider for information about AEROSPAN Inhalation Aerosol that is written for health professionals.

For more information, go to www.aerospan.net

What are the ingredients in AEROSPAN Inhalation Aerosol?

Active ingredient: Flunisolide

Inactive ingredients: propellant HFA-134a and ethanol

Instructions for Use
AEROSPAN™ (AIR-OH-SPAN)
(flunisolide)
Inhalation Aerosol

Read this Instructions for Use for AEROSPAN Inhalation Aerosol before you start using it and each time you get a refill. There may be new information. This leaflet does not take the place of talking to your doctor about your medical condition or treatment.

The parts of your AEROSPAN Inhalation Aerosol

AEROSPAN Inhalation Aerosol is an inhaler unit made up of 3 parts, the canister, actuator, and spacer. The purple inner part is called the actuator. It holds the metal canister of medicine. The gray outer part is called the spacer. It includes the mouthpiece through which you inhale the medicine (**See Figures A and B**).

- **Do not** separate the purple actuator from the gray spacer.
- **Do not** use your AEROSPAN Inhalation Aerosol purple actuator and gray spacer with any other canisters.
- **Do not** use actuators from other medicines with your AEROSPAN Inhalation Aerosol canister.
- **Do not** use your AEROSPAN Inhalation Aerosol with any other external spacers or holding chamber devices.

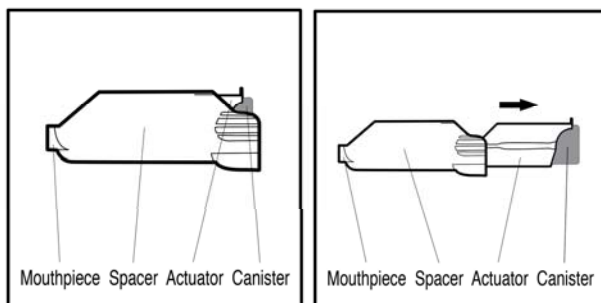

Figure A

Figure B

Opening and Positioning your AEROSPAN Inhalation Aerosol

Your AEROSPAN Inhalation Aerosol needs to be opened and positioned before you can use it.

- Pull the purple actuator out from the gray spacer. You will see that there are ribbed finger pads on the sides of the gray spacer.
- Grip the ribbed finger pads on the sides of the gray spacer with the thumb and forefinger of 1 hand (**See Figure C**).

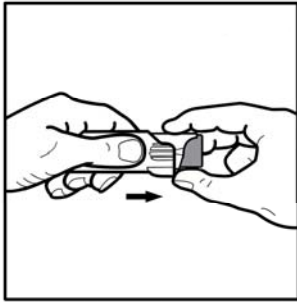

Figure C

- Gently pull on the lip at the top of the purple actuator with the other hand (**See Figure D**).
- Check the spacer and mouthpiece for foreign objects.

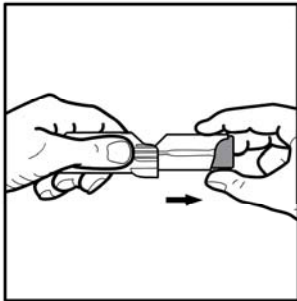

Figure D

- Snap your AEROSPAN Inhalation Aerosol into an "L" shape (90° angle). (**See Figure E**) Your AEROSPAN Inhalation Aerosol will only move in 1 direction.

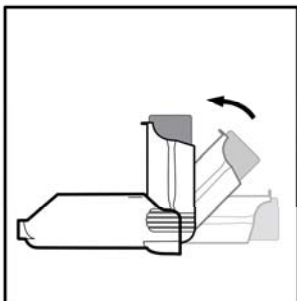

Figure E

- Check to make sure that the guide lines on the purple actuator and the gray spacer match up (**See Figure F**).

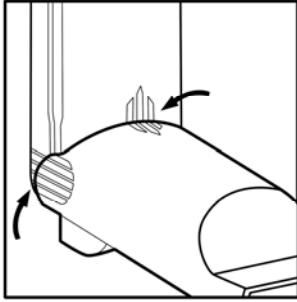

Figure F

- The lines on the ribbed finger pads of the gray spacer should match up with the lines across the back of the purple actuator.
- The lines on the top of the gray spacer and the purple actuator should match up. Make sure there is no opening at the top of the unit where the purple actuator and the gray spacer come together.
- Your AEROSPAN Inhalation Aerosol is ready for use when the lines are matched up.

Priming your AEROSPAN Inhalation Aerosol for use

- **Before you use your AEROSPAN Inhalation Aerosol for the first time, or if you have not used your medicine for more than 2 weeks, you will need to prepare (prime) your AEROSPAN Inhalation Aerosol.**
- Place the bottom of the gray spacer on the base of your thumb and your index finger on the top of the metal canister. Your hand will be at the side of the device **(See Figure G)**.

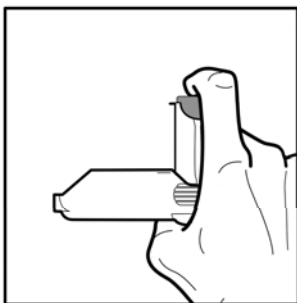

Figure G

- Check to make sure that the metal canister of medicine is placed fully into the purple actuator.
- Shake the inhaler **(See Figure H)**.

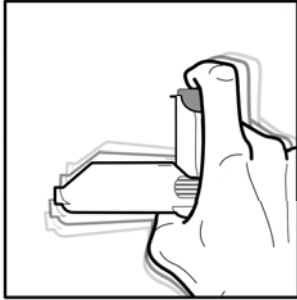

Figure H

- To avoid spraying medicine in your eyes, point the mouthpiece away from your face.
- Press down on the metal canister of medicine 2 times for 1 second each in order to release 2 test sprays into the air (**See Figure I**).

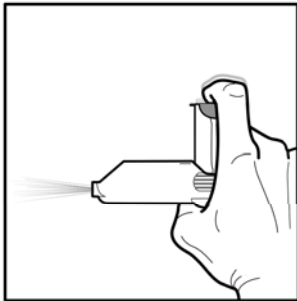

Figure I

Using your AEROSPAN Inhalation Aerosol

Step 1. Open and position your Aerospan Inhalation Aerosol by pulling the built-in purple actuator out from the gray spacer and snapping into an “L” shape prior to use (**See instructions above and Figures A through F**).

Step 2. Hold your AEROSPAN Inhalation Aerosol between your thumb and index finger and shake the inhaler (**See Figure J**).

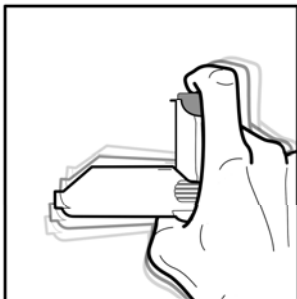

Figure J

Step 3. Stand upright with your neck and head straight. Hold your AEROSPAN Inhalation Aerosol with the metal canister facing up and the mouthpiece of the spacer facing toward you. Place your thumb on the bottom of the gray spacer and your index finger on the top of the metal canister (**See Figure K**).

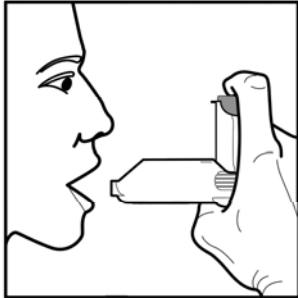

Figure K

Step 4. Breathe in (inhale) and breathe out (exhale) normally through your mouth (**See Figure L**).

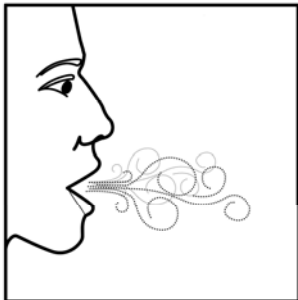

Figure L

Step 5. After breathing out, bring your AEROSPAN Inhalation Aerosol to your mouth and hold the mouthpiece firmly between your lips (**See Figure M**).

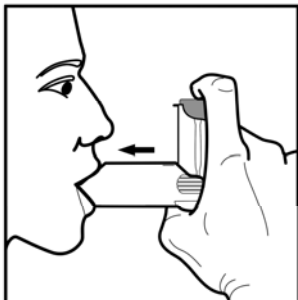

Figure M

Step 6. Start breathing in slowly. While breathing in, fully depress the metal canister of medicine with your index finger for at least 1 second. Continue to breathe in through your mouth for 3 more seconds. **(See Figure N).**

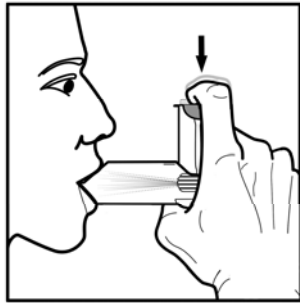

Figure N

It is important to begin breathing in through your mouth right before pressing down on the canister. This helps you get the right amount of medicine.

Step 7. After 3 seconds, remove your AEROSPAN Inhalation Aerosol from your mouth but do not breathe out yet. Close your lips and hold your breath for at least 10 seconds or as long as comfortable. **(See Figure O).**

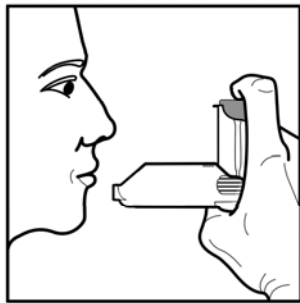

Figure O

Step 8. After 10 seconds of holding your breath, breathe out and then breathe normally **(see Figures P and Q).**



Figure P

Figure Q

NOTE: If your doctor has prescribed 2 or more sprays (inhalations) at each use, wait 20 seconds, then repeat Steps 1 to 7.

Closing your AEROSPAN Inhalation Aerosol

- Snap the purple actuator back to the straight position.
- Gently push the purple actuator back into the gray spacer (**See Figure R**).

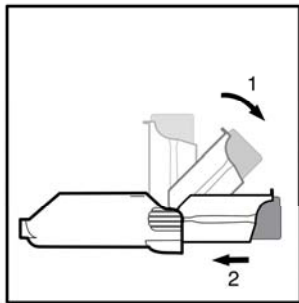

Figure R

Rinse your mouth thoroughly with water and spit it out. This removes any remaining medicine from your mouth. You may also want to brush your teeth (**See Figure S**).



Figure S

Note: If your mouth becomes sore or you get white plaques in your mouth, tell your doctor but do not stop using your inhaler unless your doctor tells you to stop.

Replacing your AEROSPAN Inhalation Aerosol

- Use a Check-Off chart to keep track of the amount of medicine you have used. Shaking the canister will not tell you how much medicine is left in your AEROSPAN Inhalation Aerosol.

- If your canister has 60 sprays, use the AEROSPAN Inhalation Aerosol 60 Sprays Check-Off chart.
- If your canister has 120 sprays, use the AEROSPAN Inhalation Aerosol 120 Sprays Check-Off chart.
- You will receive a new AEROSPAN Inhalation Aerosol each time you refill your prescription. Throw away your old AEROSPAN Inhalation Aerosol when you refill your prescription.

This Patient Information and Instructions for Use have been approved by the U.S. Food and Drug Administration.

**Manufactured By:
3M Drug Delivery Systems.
Northridge, CA 91324.**

**For:
Acton Pharmaceuticals, Inc.
Marlborough, MA 01752**

11/2012

AEROSPAN Inhalation Aerosol 60 Sprays Check-Off Chart

- Keep this Check-Off chart with your AEROSPAN Inhalation Aerosol.
- **If you are using the inhaler for the first time or if you have not used your inhaler for more than 2 weeks you will need to prepare (prime) your AEROSPAN Inhalation Aerosol.** Follow the instructions provided above in Priming your AEROSPAN Inhalation Aerosol for use.
- Check off the two circled P's (P = prime) as shown in the chart below (**See Figure 1**).
- Check off a numbered circle each time you use your inhaler. Count each spray. Start with spray # 60.
- Before you reach the last number of sprays, contact your healthcare provider to find out if you need a refill.
- Throw away your AEROSPAN Inhalation Aerosol, which includes the canister, actuator, and spacer, after 60 sprays even if the canister is not empty. You may not get the right amount of medicine in each spray if you use your AEROSPAN Inhalation Aerosol after 60 sprays.
- **Never place the canister under water to find out the amount of medicine still left in the canister ("float test").**

P = prime

Dosing Sprays

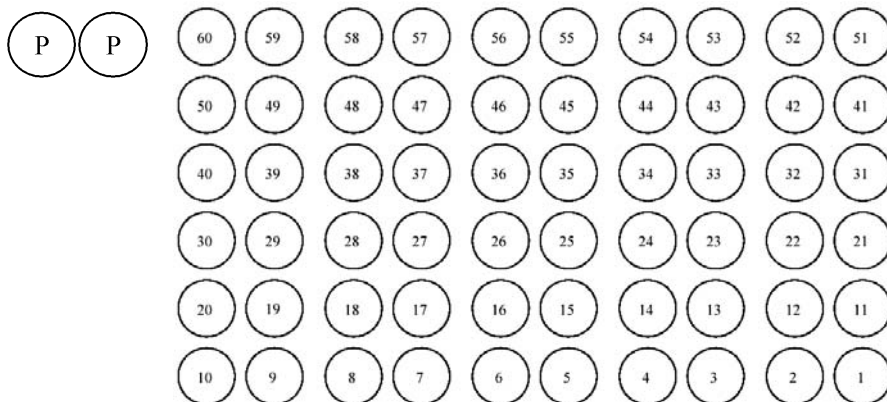

Figure 1

AEROSPAN Inhalation Aerosol 120 Sprays Check-Off Chart

- Keep this Check-Off chart with your AEROSPAN Inhalation Aerosol.
- **If you are using the inhaler for the first time or if you have not used your inhaler for more than 2 weeks you will need to prepare (prime) your AEROSPAN Inhalation Aerosol.** Follow the instructions provided above in Priming your AEROSPAN Inhalation Aerosol for use.
- Check off the two circled P's (P = prime) in the chart below **(See Figure 2)**.
- Check off a numbered circle each time you use your inhaler. Count each spray. Start with spray #120.
- Before you reach the last number of sprays, contact your healthcare provider to find out if you need a refill.
- Throw away your AEROSPAN Inhalation Aerosol, which includes the canister, actuator, and spacer, after 120 sprays have been used even if the canister is not empty. You may not get the right amount of medicine in each spray if you use your AEROSPAN Inhalation Aerosol after 120 sprays.
- **Never place the canister under water to find out the amount of medicine still left in the canister ("float test").**

P = prime

Dosing Sprays

P	P	120	119	118	117	116	115	114	113	112	111
		110	109	108	107	106	105	104	103	102	101
		100	99	98	97	96	95	94	93	92	91
		90	89	88	87	86	85	84	83	82	81
		80	79	78	77	76	75	74	73	72	71
		70	69	68	67	66	65	64	63	62	61
		60	59	58	57	56	55	54	53	52	51
		50	49	48	47	46	45	44	43	42	41
		40	39	38	37	36	35	34	33	32	31
		30	29	28	27	26	25	24	23	22	21
		20	19	18	17	16	15	14	13	12	11
		10	9	8	7	6	5	4	3	2	1

Figure 2